



## Complete Line of Easy-to-Use Compact Loggers with Expanded Memory

The new HIOKI compact data logger series easily records temperature, voltage, current, and instrumentation signals over long periods. Carried over from its highly reputed predecessor, this series includes features and functions such as 7 times the recording capacity of former models, data import during recording, continuous measurement even during battery replacement, and intuitive PC software. Flexible and easy-to-use at single and multiple locations, the new HIOKI compact data logger series is ideal for any application that requires simple set-up but long-term, reliable recording capabilities.

# Meet a Wide Variety of Data Logging Applications



**Temperature Logger /Humidity Logger**  
Manage the temperature and humidity in offices and factories. Visually monitor the data to save on air-conditioning and heating costs.



**Instrumentation Logger / Voltage Logger**  
Record fluid flow such as for water, gas and oil. Measure flow meter output signals to monitor flow trends.



**Clamp Logger**  
Manage the current consumption of plant and building equipment. Visually monitor power costs to efficiently conduct energy- and cost-saving activities.

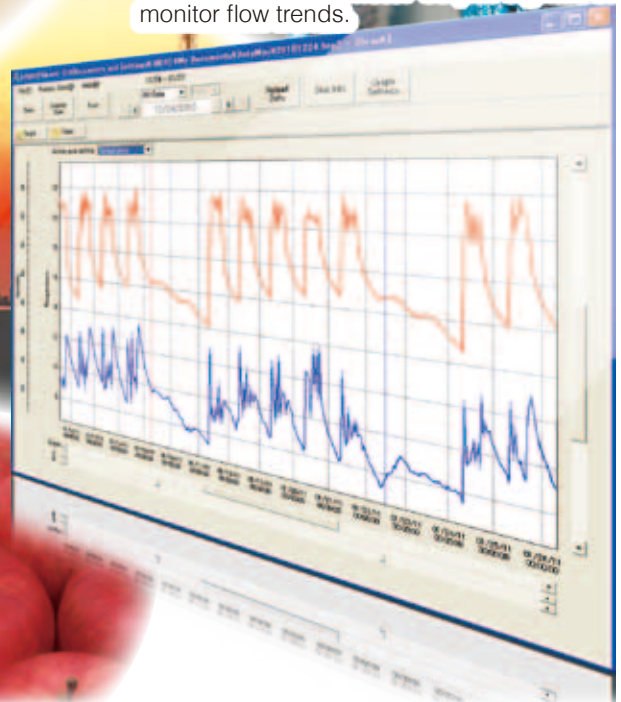

Use as a Voltage Logger to record pyranometer output for evaluating insulation.

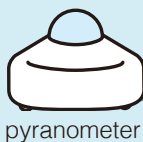

pyranometer

Voltage logger has a Preheat function

Use as a Clamp Logger and leakage sensor to record and monitor leakage trends.

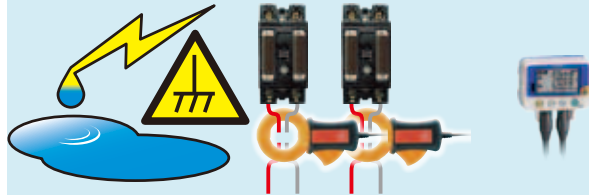

Use as a Temperature Logger to record warehouse temperatures for visually monitoring temperature changes of products and goods.



Use as an Instrumentation Logger to record pressure sensor output and monitor fluctuations in air or oil pressure.



# Easy operation in just 3 steps !

**STEP 1**  
Set up & Record

Install a Data Logger, set an interval, and start measuring.

**Easy to start recording**

Set your recording interval. (from one second to 60 minutes)

Hold the REC button for two seconds to start recording.

**Unlimited installation capabilities**

Wall-mounted Holder (sold separately) Not usable with LR5051

Magnetic Strap (sold separately)

Kickstand (included, except for Model LR5051)

**STEP 2**  
Transfer data from Data Logger to PC

Download data using infrared communication.

Communication Adapter LR5091

Grab the Data Logger from the worksite and connect to a PC.

Retrieving the Data Logger

Transfer data from Data Logger to PC using a USB connection

**!** Requires optional  
**Communication Adapter**  
or  
**Data Collector**

Download data using infrared communication.

Front Back

**Data Collector LR5092-20**

Using the Data Collector's internal memory, import data from up to 16 Data Loggers installed on site.\*

Importing to a Data Collector

Retrieving the Data Collector

Transfer data from Data Logger to PC using a USB connection

\* Data for up to 16 channels can be stored. Combine up to 16 single-channel Data Loggers (Models LR5011, LR5031, LR5041, LR5042, and LR5043), or up to eight 2-channel Data Loggers (Models LR5001, and LR5051).

Using an optional SD Memory Card, the amount of data that can be imported is practically limitless.

Top surface of LR5092-20

SD Card slot

USB Connector

Importing to an SD Memory Card

Transfer data from SD Memory Card within Data Collector to PC using USB

or

Transfer data directly from SD Memory Card

**STEP 3**  
View graphs and manage data

View data graphically and easily print using the bundled software.

# Advanced Features and Functions

## Install Almost Anywhere

Easily mount the light-weight, pocket-sized loggers in tight spaces.



Actual size

## Recording capacity up to 7 times previous models

Large internal memory stores 60,000 data points per channel. Long-term recording capability exceeds that of previous models.

Interval times	Instantaneous value	Statistical value
1s	16h 40m	-
2s	1d 9h 20m	8h 20m
5s	3d 11h 20m	20h 50m
10s	6d 22h 40m	1d 17h 40m
15s	10d 10h	2d 14h 30m
20s	13d 21h 20m	3d 11h 20m
30s	20d 20h	5d 5h
1m	41d 16h	10d 10h
2m	83d 8h	20d 20h
5m	208d 8h	52d 2h
10m	416d 16h	104d 4h
15m	625d	156d 6h
20m	833d 8h	208d 8h
30m	1250d	312d 12h
60m	2500d	625d

⚠ The maximum recording time depends on battery life. The battery may need to be replaced during long-term recording.

⚠ Customers using the previous Model 3636-20 Clamp Logger should note that the LR5051 can only record 15,000 points of average data, vs. 32,000 data points available in the 3636-20.

## Easy-to-see dual display

Temperature and humidity or current channels can be displayed. View maximum and minimum values while measuring.

## Moist environments

IP54 splash-proof rating withstands operation in extremely humid environments like kitchens and pipe rooms. (Except Model LR5051)



## Transfer data even during recording

Continue to record even when transferring data.

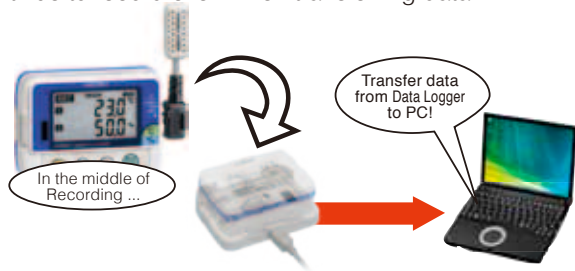

## Record without missing fluctuations

With usual (instantaneous value) recording at long intervals, detailed fluctuations occurring within the intervals are missed. However, with the statistical value recording mode, detailed fluctuations are captured even when they occur during long recording intervals. In STAT mode, measurement is taken every second, and the maximum, minimum, average, and instantaneous values within the specified interval are recorded.

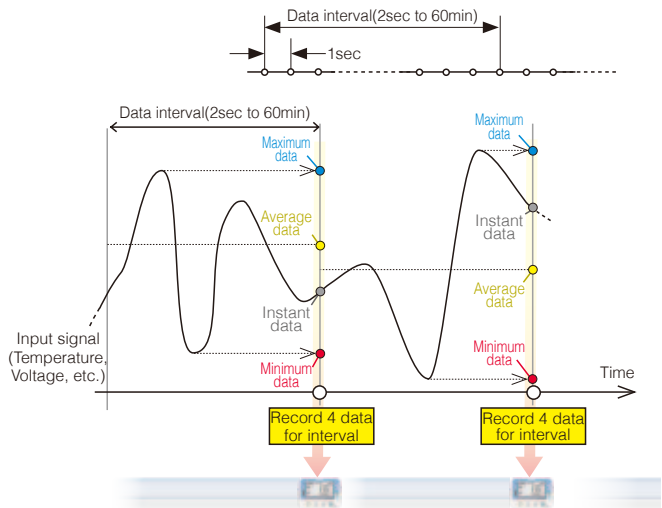

## Batteries last up to 2 years

Energy-efficient design provides up to two years of battery life (For the LR5011 only. Actual battery life depends on model type and settings).



## Replace batteries while recording

Recording continues for about 30 seconds even with the battery removed.



*Note. With the LR5001, recording is interrupted during battery replacement if the battery is very weak. After batteries are replaced, recording resumes automatically. Previously recorded data is not lost during battery replacement.*

## Never worry about a dead battery

The worry-free backup function preserves measurement data even after the battery dies.



## Never worry about operating errors

Worry-free backup preserves recorded data even if a new measurement is started by mistake.



# Bundled Software Ensures Smooth and Easy Data Analysis

## Import data to a PC and create graphs

Use the LR5000 Utility program to import Data Logger data to a PC to make graphs and analyze data further. Easily print results using your PC.

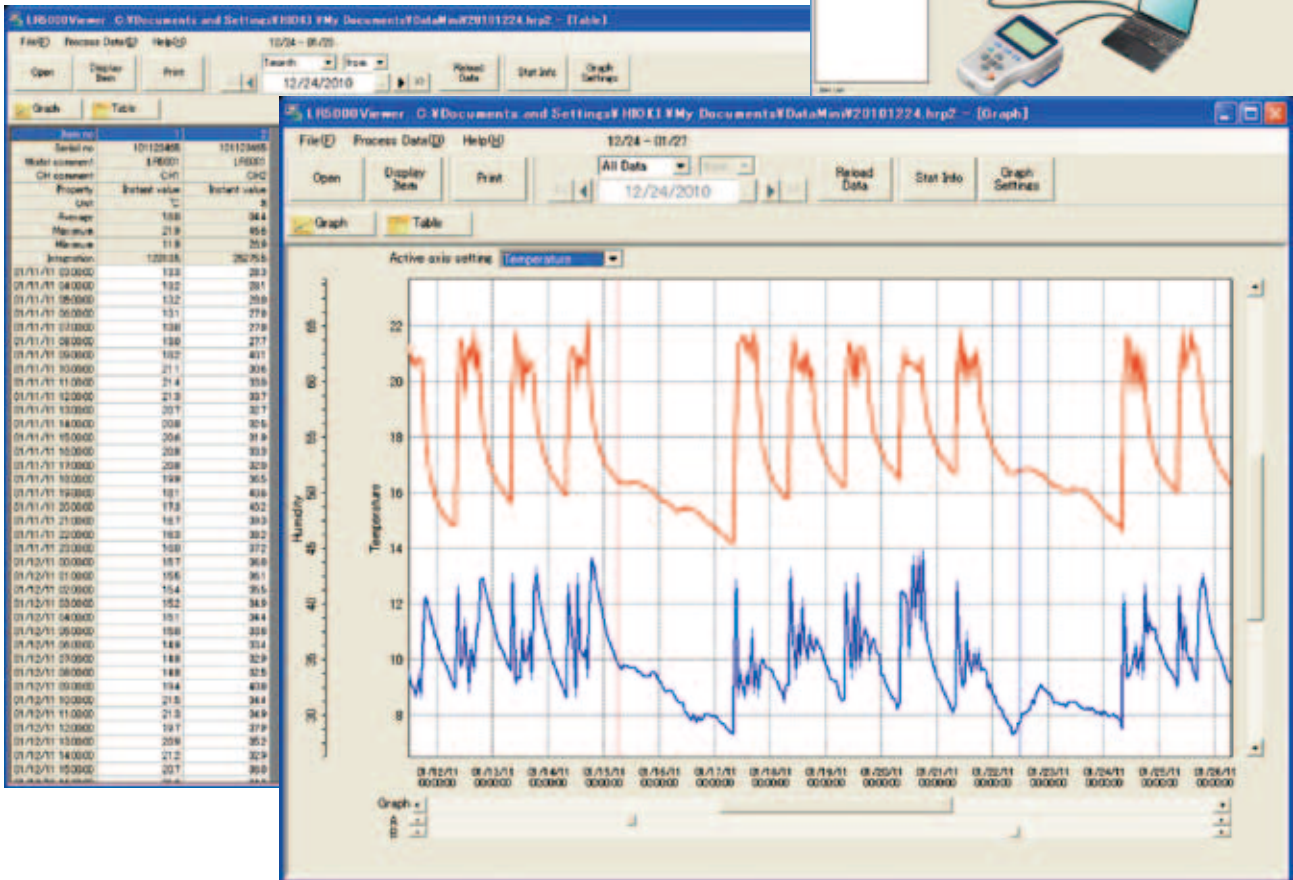

## Show specific values using the cursor function

Use the A/B cursors to select any location on a graph and display its value. The PC software can also calculate maximum, minimum, and average values between A and B cursors.

## Simple file aggregation and management

Transferred data can be combined with data previously transferred (from the same Data Logger unit) into one data on the PC.

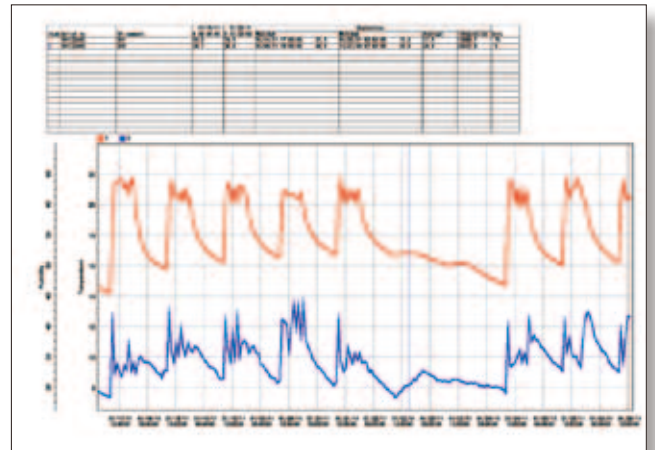
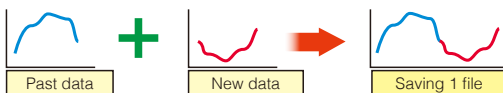

## Display data from former Data Logger models



The PC application also supports data collected from the HIOKI 36XX Series Data Loggers.



LR5000 Utility Specifications	
Configuring Data Logger	<ul style="list-style-type: none"> <li>Import/export Data Logger settings (LR5091 or LR5092-20 required)</li> <li>Settings sent to each LR5000 logger are also saved to the PC.</li> </ul>
Graph display	<ul style="list-style-type: none"> <li>Graphically display data for up to 16 channels</li> <li>Select colors and display/hide any channel and graph</li> <li>Copy graph images to clipboard</li> <li>Display statistical data (maximum, minimum and average)</li> <li>Scaling function</li> </ul>

Print function	<ul style="list-style-type: none"> <li>Print graphs</li> <li>Print statistical data.</li> </ul>
Data processing	<ul style="list-style-type: none"> <li>Scaling</li> <li>Power calculation</li> <li>Energy cost calculation</li> <li>Operating ratio calculation</li> <li>Integration</li> <li>Dew point temperature</li> <li>Calculate between channels</li> </ul>
Operating environment	<ul style="list-style-type: none"> <li>OS: Windows XP (SP2 or later) / Windows Vista (SP1 or later) / Windows 7</li> <li>CPU : 1GHz or more</li> <li>Memory : 512MB or more</li> <li>Interface : USB</li> <li>Free space in hard disk: 30MB or more</li> </ul>

# Communication Adapter and Data Collector Specifications (Product guaranteed for one year)

Physical appearance	 CE	 CE SD
Model	Communication Adapter LR5091	Data Collector LR5092-20
Features	<ul style="list-style-type: none"> <li>•Transfer data from a Data logger to a PC</li> <li>•Transfer Data Logger configurations or clock settings from a PC to the Data Logger</li> </ul>	<ul style="list-style-type: none"> <li>•Collect recorded data from the Data Logger to internal memory or SD card</li> <li>•View collected data in a graph</li> <li>•Transfer Data Logger configurations or clock settings from internal memory or SD card to the Data Logger</li> <li>•Transfer data from a Data Logger to a PC</li> <li>•Transfer Data Logger configurations or clock settings from a PC to the Data Logger</li> </ul>
Interface with Data Logger	Infrared optical communications	
Interface with PC	USB2.0, Full Speed, Series Mini B Receptacle	
Clock functions	-	Auto calender, auto leap year
Display	-	Dot-matrix LCD (128 × 64 dots)
Display items	-	Data Logger configurations (Interval, Start/Stop method, Recording mode, Scaling, Alarm, Power-saving mode, Clock, Range) Collected data (Record list, Maximum data, Minimum data, Average, Graph, Value)
Internal memory capacity of data	-	60,000 data elements ×16ch (instantaneous value mode) 15,000 data elements ×16ch (statistical value mode)
Removable storage media	-	SD Card (SDHC, Max 32GB) Save data and configurations
Operating environment	Indoors	
Power supply	DC 5 V (USB bus power) Maximum rated power 0.5 VA	DC 3 V (LR6 (AA) Alkaline battery 1.5 V×2) or DC 5 V (USB bus power) Maximum rated power 1 VA
Battery life	-	Approx. 12 hours or 500 times of data collection
Operating temperature and humidity	0°C (32°F) to 40°C (104°F), 80% RH or less (non-condensating)	
Dimensions & Mass	Approx. 83 mm (3.27 in)W × 61 mm (2.40 in)H × 19mm (0.75 in)D, 43 g (1.5 oz)	91 mm (3.58 in)W × 141 mm (5.55 in)H × 31 mm (1.22 in)D, 215 g (7.6 oz) (excluding batteries)
Accessories	USB cable (1 m)×1, CD (Application software "LR5000 Utility") × 1	Instruction manual ×1, Operation manual×1, LR6 (AA) Alkaline battery 1.5V×2, USB cable (1 m)×1, CD (Application software "LR5000 Utility") × 1

## LR5092-20 Option



SD Memory Card (2GB) Z4001

## LR5000 Series Common specifications

(Product guaranteed for one year. Accuracy guaranteed for 1 year, Post-adjustment accuracy guaranteed for 1 year)



Recording interval	1/ 2/ 5/ 10/ 15/ 20/ 30 seconds 1/ 2/ 5/ 10/ 15/ 20/ 30/ 60 minutes	Storage capacity	<b>Instantaneous value mode</b> 60,000 data sets per channel <b>Statistical value mode</b> 15,000 data sets per channel <small>Note: Customers using the previous Model 3636-20 Clamp Logger should note that the LR5051 can only record 15,000 points of average data, vs. 32,000 data points available in the 3636-20.</small>
Recording methods	<b>One time recording</b> Stop recording when the memory capacity is full. <b>Endless recording</b> Continue recording even when the memory capacity is full. (old data is overwritten.)	Display items	Measured value, Interval configuration, Date, Time, Alarm, Remaining battery power, Number of data, Maximum data, Minimum data
Recording modes (instantaneous value mode/statistical value mode)	<b>Instantaneous recording</b> Instantaneous values are recorded at every recording interval. <b>Statistical value recording</b> Measure at one second intervals, and record the instantaneous, maximum, minimum, and average values within every recording interval.	Recording start / stop	<b>Recording start</b> Manual start Timer start <b>Recording stop</b> Manual stop Timer stop When the memory capacity is full (One time recording)
		Data backup	Data from the last recording session is always backed up. Back up recorded data and configuration when battery is dead.
		Interface	Infrared optical communications with LR5091, LR5092-20
		Power supply	During battery replacement, recording and clock operations are preserved for about 30 seconds. (Recording operation continues if the battery is replaced within about 30 seconds.)  <small>Note: With the LR5001, recording is interrupted during battery replacement if the battery is very weak. After batteries are replaced, recording resumes automatically. Previously recorded data is not lost during battery replacement.</small>

## LR5000 Series common options





Magnetic Strap  
Z5004



Wall-mounted Holder  
LR9901  
Not compatible with Model LR5051

**Product Specifications** (Product guaranteed for 1 year, Accuracy guaranteed for 1 year, Post-adjustment accuracy guaranteed for 1 year) See page 6 for Common specifications

Physical appearance																																																		
Model	HUMIDITY LOGGER LR5001	TEMPERATURE LOGGER LR5011																																																
Features	Temperature and humidity are recorded simultaneously using supplied or optional temperature and humidity sensors.	Temperature measurement with external temperature sensor. Select the sensor according to the measurement object																																																
Measurement items	Temperature 1ch and Humidity 1ch	Temperature 1ch																																																
Measurement range	Temperature : -40°C to 85°C Humidity : 0% to 100% RH	-40.0°C to 180°C *Depends on measurement range of sensor.																																																
Accuracy	<table border="1"> <tr><th colspan="2">Temperature (LR5001 + Sensor)</th></tr> <tr><td>85</td><td>±2.0°C</td></tr> <tr><td>70</td><td>±1.0°C</td></tr> <tr><td>35</td><td>±0.5°C</td></tr> <tr><td>0</td><td>±1.0°C</td></tr> <tr><td>-40</td><td>±1.0°C</td></tr> </table> <table border="1"> <tr><th colspan="2">Humidity (LR5001+Sensor)</th></tr> <tr><td>10</td><td>±10%</td></tr> <tr><td>20</td><td>±8%</td></tr> <tr><td>30</td><td>±6%</td></tr> <tr><td>40</td><td>±8%</td></tr> <tr><td>50</td><td>±6%</td></tr> <tr><td>60</td><td>±5%</td></tr> <tr><td>70</td><td>±6%</td></tr> <tr><td>80</td><td>±8%</td></tr> <tr><td>90</td><td>±10%</td></tr> <tr><td>100</td><td>±15%</td></tr> </table> <p>* Values provided for reference only.</p>	Temperature (LR5001 + Sensor)		85	±2.0°C	70	±1.0°C	35	±0.5°C	0	±1.0°C	-40	±1.0°C	Humidity (LR5001+Sensor)		10	±10%	20	±8%	30	±6%	40	±8%	50	±6%	60	±5%	70	±6%	80	±8%	90	±10%	100	±15%	<table border="1"> <tr><th colspan="2">Temperature : °C (LR5011+Sensor)</th></tr> <tr><td>180</td><td>±5.0°C</td></tr> <tr><td>120</td><td>±2.0°C</td></tr> <tr><td>70</td><td>±1.0°C</td></tr> <tr><td>35</td><td>±0.5°C</td></tr> <tr><td>0</td><td>±1.0°C</td></tr> <tr><td>-40</td><td>±1.0°C</td></tr> </table>	Temperature : °C (LR5011+Sensor)		180	±5.0°C	120	±2.0°C	70	±1.0°C	35	±0.5°C	0	±1.0°C	-40	±1.0°C
Temperature (LR5001 + Sensor)																																																		
85	±2.0°C																																																	
70	±1.0°C																																																	
35	±0.5°C																																																	
0	±1.0°C																																																	
-40	±1.0°C																																																	
Humidity (LR5001+Sensor)																																																		
10	±10%																																																	
20	±8%																																																	
30	±6%																																																	
40	±8%																																																	
50	±6%																																																	
60	±5%																																																	
70	±6%																																																	
80	±8%																																																	
90	±10%																																																	
100	±15%																																																	
Temperature : °C (LR5011+Sensor)																																																		
180	±5.0°C																																																	
120	±2.0°C																																																	
70	±1.0°C																																																	
35	±0.5°C																																																	
0	±1.0°C																																																	
-40	±1.0°C																																																	
Waterproof and dust-proof performance	IP54 (splash-proof construction)																																																	
Operating temperature and humidity	-20°C (-4°F) to 70°C (158°F) , 80% RH or less (non-condensating)																																																	
Dimensions & mass	Approx. 79 mm (3.11 in)W × 57 mm (2.24 in)H × 28 mm (1.10 in)D 105 g (3.7 oz)																																																	
Power supply	LR6 (AA) Alkaline battery 1.5 V×1																																																	
Accessories	Humidity sensor LR9504×1, Kickstand	Kickstand																																																
Battery life	LR6 (AA) Alkaline battery 1.5 V×1, Instruction manual ×1, Operation manual×1																																																	
Battery life	Case 1 : Approx. 3 months Case 2: Approx. 20 days	Case 1 : Approx. 2 years Case 2: Approx. 2 months																																																
Battery life	Case 1 : 1min. recording interval, power-saving mode, Instantaneous recording, environmental temp.20°C Case 2 : 1sec. recording interval, power-saving mode, Instantaneous recording, environmental temp.20°C																																																	

Analysis of measurement data on a PC requires the optional LR5091 Communication Adapter or LR5092-20 Data Collector. See page 6 for details.  
(Reference) When the recording interval is set to 10 minutes, the LR5001 Temperature and Humidity Logger can measure for about one year between battery replacements.

**LR5001 Options Humidity Sensor**

■ Humidity Sensor

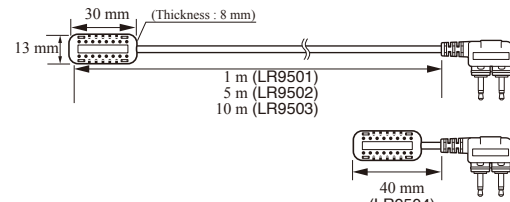

- Models (length) : LR9501 (1 m)  
LR9502 (5 m)  
LR9503 (10 m)  
LR9504 (40 mm, bundled accessory)
- Temperature range : -40.0°C to 85.0°C
- Humidity range : 0.0% to 100.0% RH
- Response time : Approximately 300 seconds (Temperature and humidity; 90% response time)

**LR5011 Options Temperature Sensor**

■ Molded plastic type

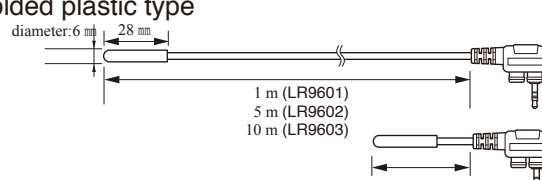

- Models (length) : LR9601 (1 m) LR9602 (5 m)  
LR9603 (10 m) LR9604 (45 mm)
- Temperature range : -40°C to 180°C
- Response time : Approx. 100 seconds (90% response time)
- Material : Cable : Silicon Sensor head : Silicon

■ Lug type

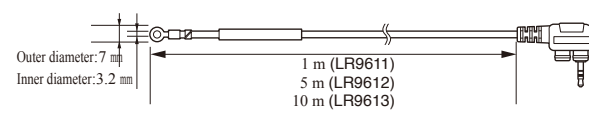

- Models(length) : LR9611 (1 m) LR9612 (5 m)  
LR9613 (10 m)
- Temperature range : -30°C to 180°C
- Response time : Approx. 45 seconds (90% response time)
- Material: Cable : Silicon Sensor head : Nickel-plated brass

■ Sheathed type

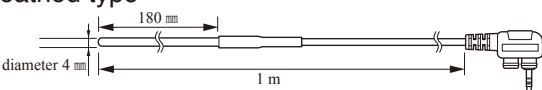





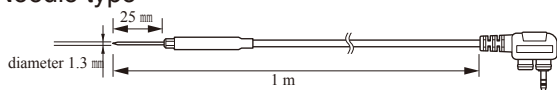

- Models(length) : LR9621(1 m)
- Temperature range : -40°C to 120°C
- Response time : Approx. 90 seconds (90% response time)
- Material : Cable : Silicon Sensor head : SUS304

■ Needle type



- Models(length) : LR9631(1 m)
- Temperature range : -40°C to 120°C
- Response time : Approx. 20 seconds (90% response time)
- Material : Cable : Silicon Sensor head : SUS304



**Product Specifications** (Product guaranteed for 1 year, Accuracy guaranteed for 1 year, Post-adjustment accuracy guaranteed for 1 year) See page 6 for Common specifications

Physical appearance	  	  
Model	INSTRUMENTATION LOGGER LR5031	VOLTAGE LOGGER LR5041, LR5042, LR5043
Features	For recording 4-20 mA instrumentation signals, etc.	For recording instrumentation signals and measuring analog outputs from sensors and other devices
Measurement items	For Instrumentation / 0 to 20 mA DC, 1ch	DC voltage 1ch
Measurement range	DC -30.00 to 30.00 mA	LR5041: -50.00 mV to 50.00 mV LR5042: -5.000 V to 5.000 V LR5043: -50.00 V to 50.00 V
Accuracy	±0.5% rdg. ±5 dgt. (@23°C ±5°C)	±0.5% rdg. ±5 dgt. (@23°C ±5°C)
Waterproof and dust-proof performance	IP54 (splash-proof construction)	
Operating temperature and humidity	-20°C(-4°F) to 70°C(158°F) , 80% RH or less (non-condensating)	
Dimensions & Mass	Approx. 79 mm (3.11 in)W × 57 mm (2.24 in)H × 28 mm (1.10 in)D, 105 g (3.7 oz)	
Power supply	LR6 (AA) Alkaline battery 1.5 V×1	
Accessories	Connection Cable LR9801×1, Kickstand LR6 (AA) Alkaline battery 1.5 V×1, Instruction manual ×1, Operation manual×1	Connection Cable LR9802×1, Kickstand LR6 (AA) Alkaline battery 1.5 V×1, Instruction manual ×1, Operation manual×1
Battery life	Case 1 : Approx. 2 years Case 2: Approx. 2 months Case 1 : 1min. recording interval, power-saving mode, Instantaneous recording, environmental temp.20°C Case 2 : 1 sec. recording interval, power-saving mode, Instantaneous recording, environmental temp.20°C	
Other	-	Preheat function (When using preheat function, a separate external power supply is required.)

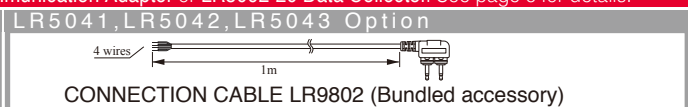









Analysis of measurement data on a PC requires the optional LR5091 Communication Adapter or LR5092-20 Data Collector. See page 6 for details.

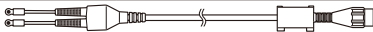

**Product Specifications** (Product guaranteed for 1 year, Accuracy guaranteed for 1 year, Post-adjustment accuracy guaranteed for 1 year) See page 6 for Common specifications

Physical appearance	   *Sensor is sold separately. *For customers using the previous Model 3636-20 Clamp Logger, please note the difference in recordable average data points available in the LR5051. (Please refer to page 4.)
Model	CLAMP LOGGER LR5051
Features	Recording load current of 50Hz/60Hz Recording leak current *Current and leak current that occur intermittently cannot be measured.
Measurement items	AC Current (2 channels)
Measurement range	When Using 9669 : 1000 A range When Using CT6500 : 50.00 A / 500.0 A range When Using 9695-02 : 5.000 A / 50.00 A range When Using 9675 : 500.0 mA / 5.000 A range When Using 9657-10 : 500.0 mA / 5.000 A range
Accuracy	±0.5% rdg. ±5dgt. +Clamp sensor accuracy
Waterproof and dust-proof performance	Not waterproof
Operating temperature and humidity	-0°C (32°F) to 50°C (122°F) , 80% RH or less (non-condensating)
Dimensions & mass	Approx. 79 mm (3.11 in)W × 70 mm (2.76 in)H × 37 mm (1.46 in)D, 165 g (5.8 oz)
Power supply	LR6 (AA) Alkaline battery 1.5V × 2
Accessories	LR6 (AA) Alkaline battery 1.5V × 2 Instruction manual ×1, Operation manual×1
Battery life	Case 1 : Approx. 1 years Case 2: Approx. 1 months Case 1 : 1min. recording interval, power-saving mode, Instantaneous recording, environmental temp.20°C Case 2 : 1 sec. recording interval, power-saving mode, Instantaneous recording, environmental temp.20°C

Analysis of measurement data on a PC requires the optional LR5091 Communication Adapter or LR5092-20 Data Collector. See page 6 for details.

<b>LR5051 Options</b>			
Load current	Cord length : Approx. 3m	Cord length : Approx. 3m	Connection cord 9219 is required (sold separately)
Physical appearance	 	 	 
Model	CLAMP ON SENSOR 9669	CLAMP ON SENSOR CT6500	CLAMP ON SENSOR 9695-02
Measurable conductor diameter	φ55 mm (2.17") or less, 80 (3.15") × 20 (0.79") mm busbar	φ46 mm (1.81") or less	φ15 mm (0.59") or less
Primary current rating	1000 A AC	500 A AC	50 A AC
Accuracy (45Hz to 66Hz)	±1.0% rdg. ±0.01% f.s.	±1.5% rdg. ±0.03% f.s.	±0.3% rdg. ±0.02% f.s.
Maximum rated voltage to earth	CAT III 600 V rms	CAT III 600 V rms	CAT III 300 V rms
Maximum allowable input (45 to 66 Hz)	1000 A continuous	600 A continuous	60 A continuous
Dimensions & mass	99.5 (3.92")W × 188 (7.40")H × 42 (1.65")D mm, 590 g (20.8 oz.)	77 (3.03")W × 151 (5.94")H × 42 (1.65")D mm, 360 g (12.7 oz.)	51 (2.01")W × 58 (2.28")H × 19 (0.75")D mm, 50 g (1.8 oz.)
	 length : 3m (9.84ft) Connection Cord 9219 (For 9695-02 connection)		
Load current	Insulated conductor Cord length : Approx. 3m	Insulated conductor Cord length : Approx. 3m	
Physical appearance	 	 	
Model	CLAMP ON LEAK SENSOR 9675	CLAMP ON LEAK SENSOR 9657-10	
Measurable conductor diameter	φ30 mm	φ40 mm	
Primary current rating	5 A AC (Using with LR5051)	5 A AC (Using with LR5051)	
Accuracy (45Hz to 66Hz)	±1.0% rdg. ±0.005% f.s.	±1.0% rdg. ±0.05% f.s.	
Lag current	1 mA (When 10 A AC is input)	5 mA (When 100 A AC is input)	
Measurable conductor	Insulated conductor	Insulated conductor	
Maximum allowable input (45 to 66 Hz)	10A continuous	30A continuous	
Dimensions & mass	60 (2.36")W × 113 (4.45")H × 24 (0.94")D mm, 160g (5.6 oz.)	74 (2.91")W × 145 (5.71")H × 42 (1.65")D mm, 380g (13.4 oz.)	

Note: Company names and Product names appearing in this catalog are trademarks or registered trademarks of various companies.

**HIOKI**

HIOKI E. E. CORPORATION

**HEADQUARTERS**

81 Koizumi, Ueda, Nagano, 386-1192, Japan  
TEL +81-268-28-0562 FAX +81-268-28-0568  
http://www.hioki.com / E-mail: os-com@hioki.co.jp

**HIOKI USA CORPORATION**

TEL +1-609-409-9109 FAX +1-609-409-9108  
http://www.hiokiusa.com / E-mail: hioki@hiokiusa.com

HIOKI (Shanghai) SALES & TRADING CO., LTD.  
TEL +86-21-63910090 FAX +86-21-63910360  
http://www.hioki.cn / E-mail: info@hioki.com.cn

HIOKI SINGAPORE PTE. LTD.  
TEL +65-6634-7677 FAX +65-6634-7477  
E-mail: info-sg@hioki.com.sg

HIOKI KOREA CO., LTD.  
TEL +82-2-2183-8847 FAX +82-2-2183-3360  
E-mail: info-kr@hioki.co.jp

DISTRIBUTED BY